



RC-122 / RC-122B Two Stage Heat/Cool 2 Stage Heat / 2 Stage Cool Thermostat Installation Instructions

DESCRIPTION

The RC-122 is a precision digital thermostat designed for 24 VAC two-stage heating and cooling systems. It offers programmability, stand-alone operation, and robust, optically isolated communications with automation systems, utility control systems, and personal computers. The RC-122B is equipped with a “cool blue” backlight display.

Electrical rating:	24 V; 3 A; 50/60 Hz
Maximum current:	2 A on any circuit, 3 A total
Thermostat operating current:	less than 15 mA

The following requirements must be observed for installation in Europe: CE

1. This equipment must be installed in accordance with National wiring rules for the country in which it is installed.
2. Fuses must be replaced only with IEC rated components.
3. All product labels, instructions and markings relating to safety must be translated to a language, which is acceptable in the country in which this equipment is to be installed.

INSTALLATION

Before installing this thermostat:

1. Read all of the installation instructions carefully.
2. Read the Owner's Manual carefully.
3. Ensure that this product is suitable for your application.
4. Ensure that wiring complies with all codes and ordinances.
5. Disconnect power to the control transformer to prevent electrical shock and damage to equipment.
6. Select an appropriate location to ensure an accurate temperature reading.

Location

When replacing an existing thermostat, install the RC-122 in the same location. If the existing location doesn't meet the following criteria, choose a new location. When choosing a location for the thermostat:

1. Ensure that the thermostat is mounted 5 feet above the floor and is at least 2 feet from an outdoor wall.
2. Ensure that the thermostat is located in an area where there is adequate air circulation.
3. Do not mount in the path of direct sunlight or of radiant heat generated by appliances.
4. Do not mount behind an outdoor wall, near a fireplace, or in the path of any air ducts.

Document Number 13100-17 / Rev B / April, 2004
Copyright © 1999-2004 Home Automation, Inc.
All Rights Reserved

Removing an existing thermostat

1. Disconnect the power to the control transformer.
2. Remove the cover to the existing thermostat.
3. Disconnect the wires going to each terminal on the thermostat. Label each wire with the letter or number at the terminal.
4. Remove the existing plate or base from the wall.

MOUNTING

When mounting the RC-122, grasp the thermostat by the sides, avoiding the keys, and unsnap the base from the face.

Holding the base to the wall so that the word "TOP" is upright and facing you:

1. Mark the two mounting holes on the wall using a pencil.
2. Drill a hole using a 3/16" bit at each mounting hole marking.
3. Install the two wall anchors supplied.
4. Slide the system wires through the opening in the base.
5. Mount the base to the wall using the two #6 x 1/2" self-tapping screws supplied - *See Figure 1.*

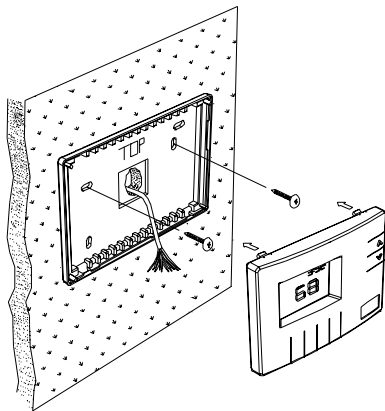

Figure 1

Connect each wire to the terminal strip on the thermostat base per the wiring diagram for your system application - See Figures 4 - 5.

Form the thermostat wiring so that the cable lies flat between the terminal strip and the center of the base.

If a remote system is being used with the thermostat, connect the remote system wiring to the supplied cable using the wire splices per the diagram for your remote system application - See Figures 7 - 8. Insert the cable into the connector on the thermostat circuit board marked "COMM".

Upon completion of wiring the thermostat, push all excess wiring into the hole in the wall. Plug the hole with the supplied insulating foam to ensure an accurate temperature reading by the thermostat.

Align the tabs of the thermostat face with the slots of the thermostat base. Gently push the thermostat face into the thermostat base locking it into place - See Figure 2.

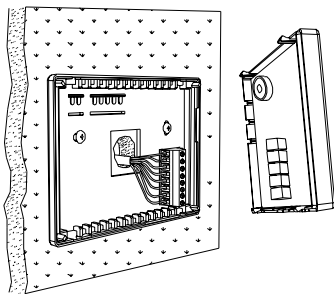

Figure 2

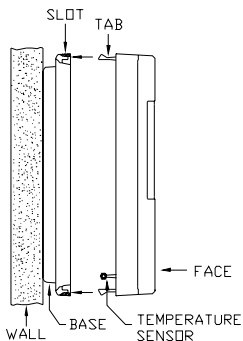

Figure 3

Note:

Be sure that the thermostat temperature sensor is standing up, and that it has not been damaged during installation - See Figure 3.

TYPICAL WIRING DIAGRAMS



CAUTION:

Be sure to disconnect the power to the control transformer before removing or installing thermostat.

Do not short gas valve(s), fan, heat relay(s), or cool relay(s)... even momentarily. This will blow a non-replaceable fuse.

Do not attempt to hook up to live circuits. An accidental connection to a component on the thermostat circuit board could cause damage to the thermostat.

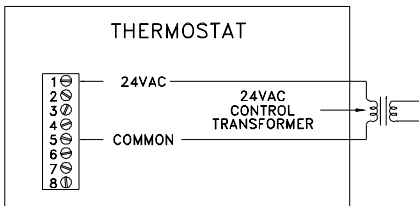

Figure 4 - Thermostat power-up for test or demonstration purposes

NOTE: As a convenience to the installer, the compressor start up protection delay can be canceled. To cancel the delay, press the Prog key 3 times, then press the Fan key 2 times.

POWER UP

1. Double check wiring, be sure that there are no stray wires or wire strands at the connections.
2. It is not necessary to connect the remote system (COMM) cable at this time.
3. Connect power to the transformer and system. The display will show all segments for about 5 seconds.
4. Press the Fan key. The fan should come on. Press the Fan key again. The fan should go off.
5. Press Hold to override Energy Efficient Control routines.
6. Set the Mode to "HEAT". Use the up arrow key to raise the desired temperature setting 1 degree above the current temperature. Ensure that Stage 1 heat comes on. After a few minutes, raise the desired temperature 3 degrees over the current temperature. Stage 2 heat should come on. Set the mode to "OFF". Ensure that the heat unit goes off.
7. Set the Mode to "COOL". Use the down arrow key to lower the desired temperature setting 1 degree below the current temperature. Ensure that Stage 1 cool comes on. After a few minutes, lower the desired temperature 3 degrees below the current temperature. Stage 2 cool should come on. Set the mode to "OFF". Ensure that the cooling unit goes off.

If the thermostat or system does not perform as stated above, recheck all wiring - **See Troubleshooting Tips.**

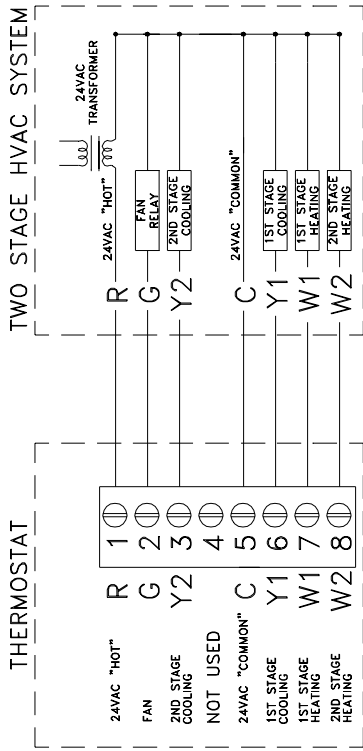

Figure 5

CONFIGURING THE BACKLIGHT ON THE RC-122B

The backlight on the RC-122B can be configured to one of three different modes: 1) on for 30 seconds when a key is pressed, 2) always on, or 3) always off.

- 1) To configure the display backlight to turn on when a key is pressed, then back off 30 seconds later, set the “JP2” (Select Backlight Mode) jumper to the “TIMED” position (between the top and middle pin on the connector) - See *Figure 6*.
- 2) To configure the display backlight to always be on, set the “JP2” (Select Backlight Mode) jumper to the “ON” position (between the middle and bottom pin on the connector) - See *Figure 6*.
- 3) To configure the display backlight to never come on (always off), remove the “JP2” (Select Backlight Mode) jumper from the connector - See *Figure 6*.

DISABLE KEYS

The keys on the thermostat can be disabled to prevent anyone from controlling the thermostat locally. To disable the keys, solder a wire jumper across “JP1” (two holes on the circuit board) - See *Figure 6*.

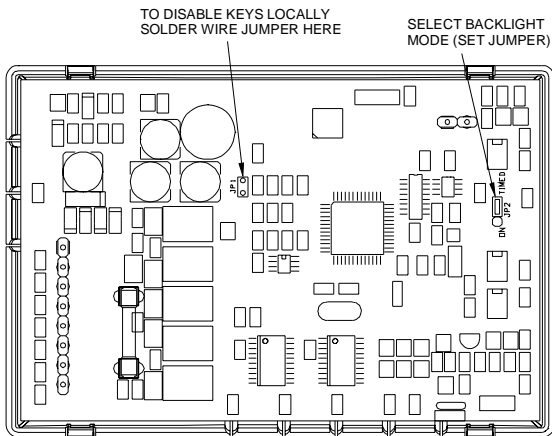

Figure 6

INSTALLER SETUP

This section describes the items that the installer must setup as part of the thermostat installation. The Installer Setup mode is used to configure the general operating parameters of the thermostat.

When in Installer Setup mode:

1. The small digits on the top of the display are the item number.
2. The large blinking digits in the center of the display are the value of the item number.
3. Press the Prog (>) key to advance to the next item.
4. Press the Hold (<) key to return to the previous item.
5. Use the arrow keys (^-v) to change the value of each item.
6. Do not set the values to anything other than the specified range for each item.
7. To exit Setup mode, press the Fan key.

The thermostat will automatically exit Setup mode after 20 seconds of no key activity.

To enter the Installer Setup mode, press the Prog key three times (day will flash), then press the Fan key.

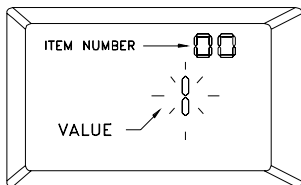

The word "default" indicates the initial setting when the thermostat is delivered from the factory.

00 Address

If you are using Communications Mode 0 or 1, and you are installing more than one thermostat, each must be set to a consecutive address, starting at 1. The default address setting is 1.

An address from 1- 127 may be selected.

01 Communications mode

The thermostat can communicate with remote systems in 4 different modes. These modes are:

- 0 300 baud, RS-232 mode (for use with personal computers)
- 1 100 baud, System mode (OmniLT, Omni, Omni II, OmniPro, and OmniPro II systems)
- 8 PESH mode, (use with Model 1503 automation systems)
- 24 Day/Night mode (for use with remote setback switch)

The default setting is 1.

02 System options

The thermostat can be configured with the following system options:

WITH <u>EEC</u>	NO <u>EEC</u> *		
0	8	Auto changeover	no fan with heat
1	9	Auto changeover	fan on with heat
4	12	Manual changeover	no fan with heat
5	13	Manual changeover	fan on with heat

* Energy Efficient Control (EEC): In most two-stage installations, stage 2 is less efficient than stage 1. In this case, Energy Efficient Control (EEC) should be turned on (settings 0, 1, 4, and 5). If the system is equipped with a highly efficient second stage, you may want to turn EEC off (settings 8, 9, 12, and 13). The thermostat will act like a conventional two-stage thermostat.

See Owner's Manual for description of EEC.

The default setting is 0.

03 Display options

The thermostat can be configured to display the following attributes:

0	Celsius	am/pm time format	programmable
1	Fahrenheit	am/pm time format	programmable
2	Celsius	24-hour time format	programmable
3	Fahrenheit	24-hour time format	programmable
4	Celsius	am/pm time format	non-programmable
5	Fahrenheit	am/pm time format	non-programmable
6	Celsius	24-hour time format	non-programmable
7	Fahrenheit	24-hour time format	non-programmable

When connected to an HAI controller, the thermostat should be configured as "non-programmable". To disable the clock and filter reminder displays, add "16" to each value.

The default setting is 1.

04 Calibration offset

This item is used to raise or lower the current temperature reading by 1 degree Fahrenheit or 1/2 degree Celsius. If this item is set to 30, no change will be made. Each digit below 30 will lower to temperature, and each digit above 30 will raise the temperature.

(1 = “- 29” to 59 = “+ 29” temperature units; 30 = No change)

The default setting is 30.

05 Cool setpoint limit

This item is used to limit the temperature setting in cool mode. The desired cool setting can never be set below this setting.

The default setting is 51.

06 Heat setpoint limit

This item is used to limit the temperature setting in heat mode. The desired heat setting can never be set above this setting.

The default setting is 91.

07 Not used

08 Not used

09 Not used

10 Not used

11 Cooling minimum on/off time (minutes)

This item is used to limit the on and off times of the cooling system. When the cooling system starts, it must remain on for the minimum time set by this item. When the cooling system turns off, it must remain off for a minimum time set by this item.

Setting	Cycles per hour (maximum)
5	6
6	5
7	4
8	3.7
10	3

The recommended setting is 8 minutes. A higher setting may be appropriate for buildings with low heat loss/gain. The default setting is 8.

12 Heating minimum on/off time (minutes)

This item is the same as the “Cooling minimum on/off time”, but for the heating system.

The default setting is 8.

13 Stage 2 Differential

This item specifies the temperature difference between stage 1 and stage 2. The default setting of 2 (degrees F) is recommended for all applications. In special cases a setting of 3 or 4 may be used when precise control of temperature is not as important as highest energy efficiency, however, the thermostat will not be able to maintain temperature within 1 degree of its setting under severe weather conditions. A setting of 1 or 0 is not recommended. The default setting is 2.

In this thermostat, the automatic anticipator will compensate for the temperature “droop” caused by the stage 2 differential under cold weather conditions.

14 Clock adjust

If the clock on the thermostat is running faster or slower than the actual time, you can have the thermostat automatically compensate up to 29 seconds per day. The thermostat will add or subtract the selected amount of time daily.

(1 = “- 29” to 59 = “+ 29” seconds per day; 30 = No change)

The default setting is 30.

Note: If an HAI automation system is being used, the controller system time is sent to the thermostat every minute. This adjustment will have no effect.

15 Filter reminder

The thermostat logs the amount of time the system fan has been running. When this setting reaches 0, the thermostat will display a reminder to replace the filter. The setting is the amount of days (24 hours of system operation) before this reminder is displayed.

Days - Counting down from 10 - 0

The filter reminder can be disabled by setting this item to 60.

16 System runtime (This week)

This item logs the amount of time (hours) that the heating and cooling system was in operation this week.

17 System runtime (Last week)

This item logs the amount of time (hours) that the heating and cooling system was in operation last week.

ANTICIPATION

Anticipation is performed electronically and is independent of the type and load of the components in the heating and cooling equipment. This thermostat has electronic control based on proportional, integral and derivative components and maintains temperature to within 1 degree F of the setting. Anticipation is not adjustable.

OWNER'S MANUAL

Following Installer Setup, check the option boxes () in the Owner's Manual according to the configuration of the thermostat.

QUICK-REFERENCE SETUP GUIDE

This table displays each Installer Setup item with its default setting. The column labeled "CURRENT" can be used to write down the current settings if any changes are made to the default settings.

Item Number	Description	Default	Current
00	Address	1	
01	Communication mode	1	
02	System options	0	
03	Display options	1	
04	Calibration offset	30	
05	Cool setpoint limit	51	
06	Heat setpoint limit	91	
07	Not used	-	
08	Not used	-	
09	Not used	-	
10	Not used	-	
11	Cooling minimum on/off time	8	
12	Heating minimum on/off time	8	
13	Stage 2 differential	2	
14	Clock adjust	30	
15	Filter reminder	10	
16	System runtime (This week)	-	
17	System runtime (Last week)	-	

REMOTE SYSTEM WIRING DIAGRAMS

This thermostat has been preprogrammed with energy saving settings recommended under the EPA Energy Star program. When used with remote systems, HAI recommends that the thermostat be configured as "non-programmable" (See Setup Item 03 - "Display Options").

HAI AUTOMATION SYSTEMS

The thermostat can be connected to an HAI automation system. The controller can send commands to the thermostat to change mode, cool setting, heat setting, status of fan and hold, and other items.

Run a 3 (or 4) conductor wire from the HAI system to the thermostat location. All thermostats on an Omni, Omni II, OmniPro, or OmniPro II controller are connected to Zone 16 and Output 8.

All thermostats on an OmniLT controller are connected to the GRN (Green), BLK (Black), and YEL (Yellow) terminals in the section marked "TSTAT".

Connect the red COMM cable wire with the black COMM cable wire. Make the connections (*as shown in Figure 7*) using the supplied wire splices.

Note: Do not connect the red COMM cable wire to 12V.

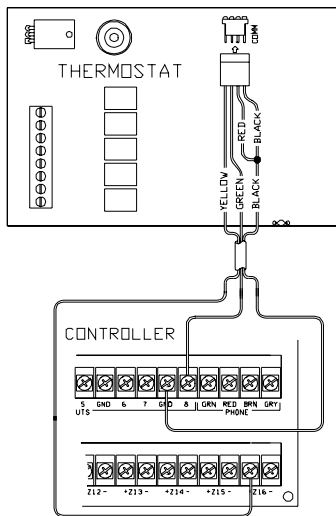

Figure 7 - Hookup to an HAI system

Additional thermostats are connected in parallel. They may be connected in home-run or daisy chain configuration.

REMOTE DAY/NIGHT SETBACK SWITCHES

The thermostat can be connected to a remote system or remote switch. A signal can be sent from the remote location to change the thermostat temperature settings from the "DAY" setting to the "NIGHT" setting. To use this mode, setup item 01 - "Communications mode" must be set to 24.

Run a two-conductor wire from the remote system or remote switch to the thermostat location. Make the connections using supplied wire splices - See *Figure 8*.

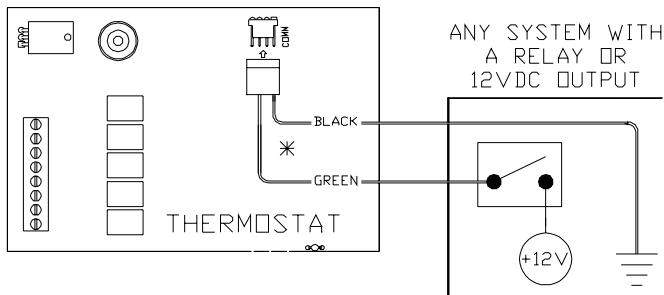

- * Red and yellow wires are not used.
Insulate each using a small piece of tape.

Figure 8 - Hookup to remote Day/Night setback switch

OTHER SYSTEMS

For connections to personal computers, utility management systems, and other automation systems, refer to connection diagrams provided with personal computer software package or other system.

TROUBLESHOOTING TIPS

SYMPTOM	ACTION TO TAKE
Thermostat Dead	1. Check power to the thermostat
	2. Check wiring diagrams
	3. Check thermostat temperature sensor
Thermostat will not operate with a damaged temperature sensor	
SYMPTOM	ACTION TO TAKE
Fan, Heat, Or Cool Inoperative	1. Check for break in G, W, or Y wire
	2. Allow minimum off time to pass
	3. Check system options for correct settings
	4. Remote system is overriding thermostat
"REMOTE" is displayed when system is overriding thermostat. Disconnect the cable from "COMM" connector to test	
SYMPTOM	ACTION TO TAKE
Can't Adjust Temperature	1. Mode is Off (Select Heat, Cool, or Auto)
	2. Check if thermostat keys are disabled
To enable thermostat keys for test, remove jumper	
SYMPTOM	ACTION TO TAKE
Control By Remote System Not Working	1. Check COMM connector and wiring
	2. Check thermostat address setting
	3. Check communications mode setting
	4. Check setup of the remote system
Ensure that all setup items for the thermostat and the remote system are set to the proper configurations for communication	
SYMPTOM	ACTION TO TAKE
Temperature Reading Incorrect	1. Allow 30 minutes for thermostat to adjust to room temperature
	2. Adjust calibration offset
	3. Change setup option to display °F or °C
After installation, allow the thermostat up to 30 minutes for an accurate temperature reading	
SYMPTOM	ACTION TO TAKE
Display Problem	1. Disconnect power to the thermostat. Reconnect, then observe display self-test
For a 5 second period after power is reconnected, all segments of the display should light indicating all thermostat functions	

SYMPTOM	ACTION TO TAKE
Stage 2 On Too Often	1. Stage 1 is not able to meet the load due to severe weather
	2. EEC is disabled
SYMPTOM	ACTION TO TAKE
No Stage 2 Operation	1. System may be equipped with an outdoor thermostat which is overriding Stage 2 the when outdoor temperature is mild
	2. Stage 1 is heating and cooling adequately